

2023-9-13

LANDWELL Key Cabinets
Installation Guide
For
2G i-keybox

Beijing Landwell Electron Technology Co., Ltd

1. Planning the Position

The Positioning of the key cabinet is a very important part of the installation process and is time well spent as poor planning will result in problems later down the line. From experience, things to take into account are:

- Who will use the key cabinet.
- 24 hours access. The key system should be positioned conveniently for the users.
- Security. The system is not designed as a high security safe, it's used to control and manage keys. The security of its location should be provided by the clients, so please place it in the view of the monitoring system.
- Indoor. We expect it to be used in ambient dry conditions rather than in exposed locations.
- Wall. The i-keybox systems can be quite heavy and therefore need a strong wall to fix to. And please ensure that any flammable materials, for example wall paper, are completely removed before fixing the cabinet to the wall.
- Others. In addition, the user's height, accessibility to the disabled, sunlight and other factors should also be considered.

2. Preparation

Before installing the system, you should ensure that the following items are in place and working properly.

- A mains power supply.
- Mounting System Provided: wall bracket, drywall anchors, screws.
- Suitable Tools. Impact drill, drill bits, hammer, level ruler, pen or pencil, network crimper, screwdrivers, and so on.
- Networking. If you will use Ethernet to network the system, you need to install a convenient RJ45 wall socket near the system.

3. Installation

3.1 S Size

Step 1. Locate the unit on the wall where you want it to go. As a guide the top of the unit should be 1.60 – 1.70 meters from the floor and should be no further than 1 meter from the mains spur.

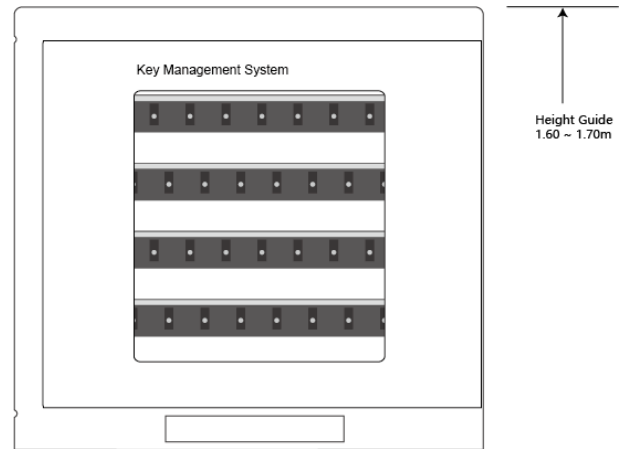

Step 2. Mark and drill 6 fixing holes and attach the wall bracket to the wall using the appropriate fixings.

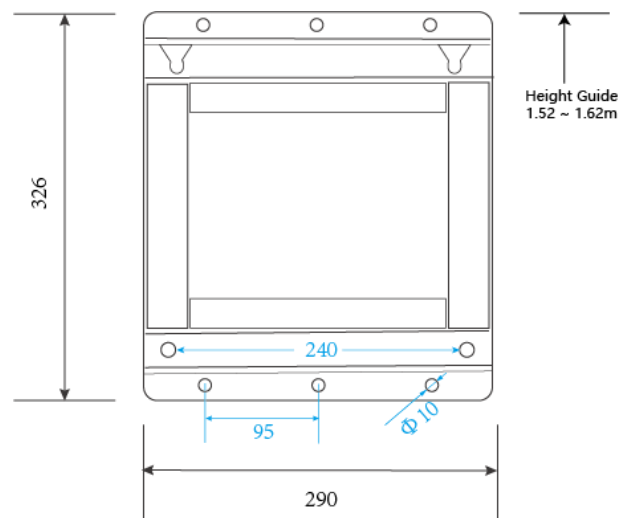

Step 3. Plug the power [and the ethernet] plugs.
Hang the key cabinet firmly on the bracket.

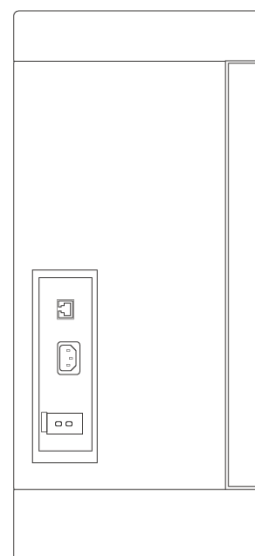

Step 4. Open the door, unscrew the two fixing screws, and then open the Key Panel using master keys.

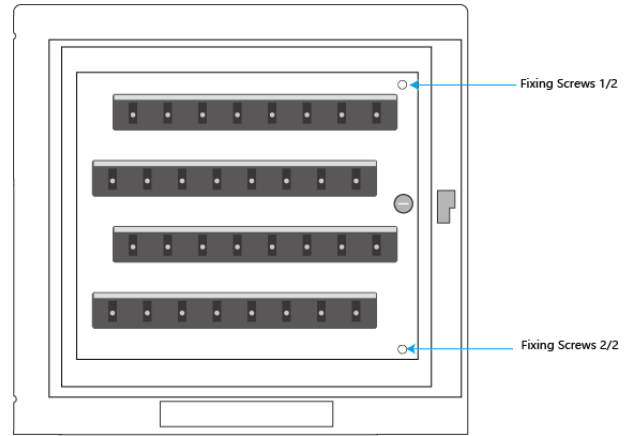

Step 5. Attach it to the bracket.

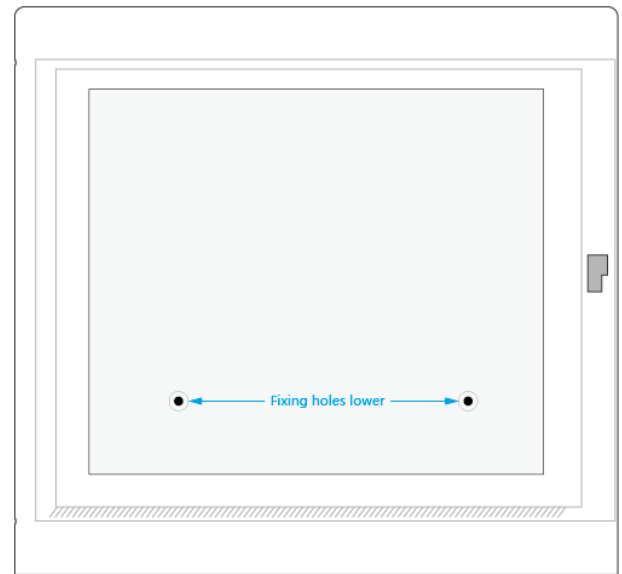

3.2 M Size

Step 1. Locate the unit on the wall where you want it to go. As a guide the top of the unit should be 1.60 – 1.70 meters from the floor and should be no further than 1 meter from the mains spur.

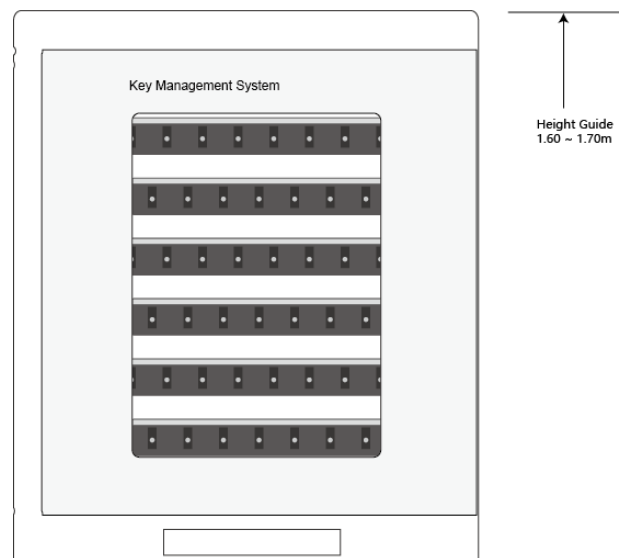

Step 2. Mark and drill 6 fixing holes and attach the wall bracket to the wall using the appropriate fixings.

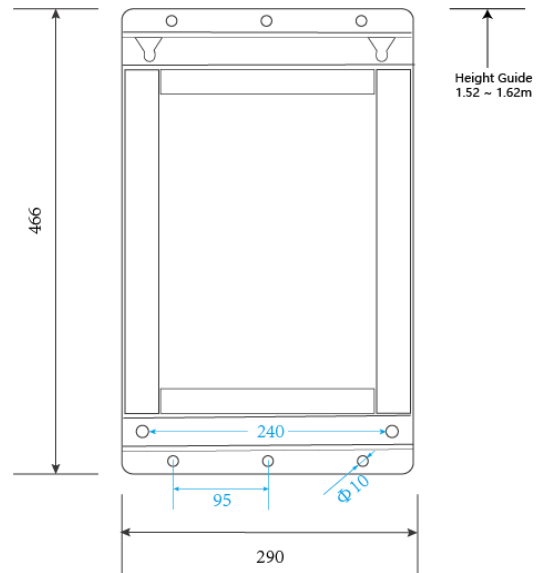

Step 3. Plug the power [and the ethernet] plugs. Hang the key cabinet firmly on the bracket.

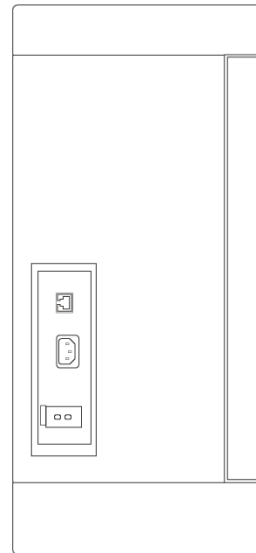

Step 4. Open the door, unscrew the two fixing screws, and then open the Key Panel using master keys.

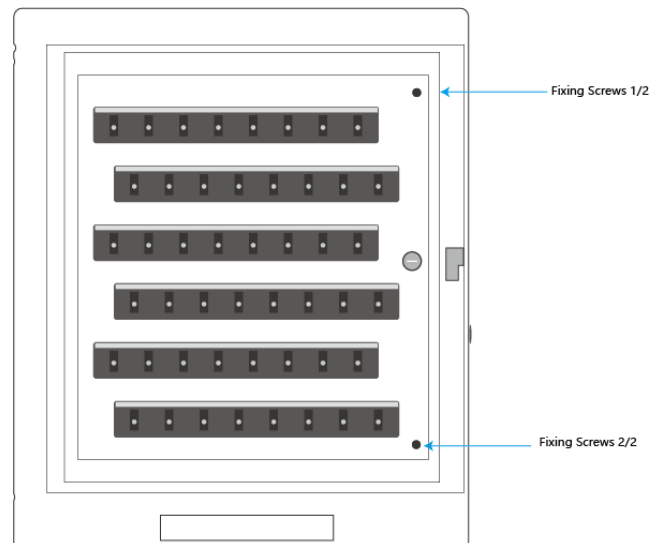

Step 5. Attach it to the bracket.

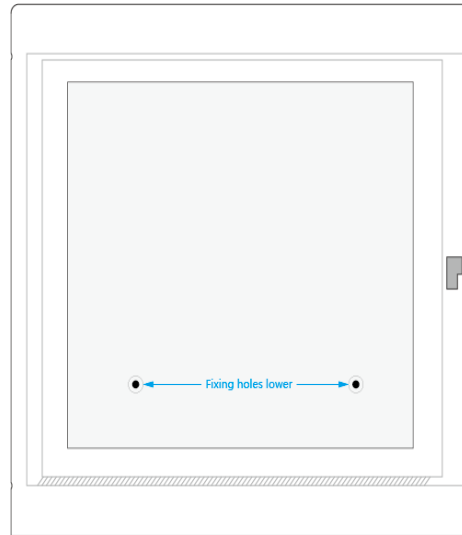

3.3 L Size

Step 1. Locate the unit on the wall where you want it to go. As a guide the top of the unit should be 1.60 – 1.70 meters from the floor and should be no further than 1 meter from the mains spur.

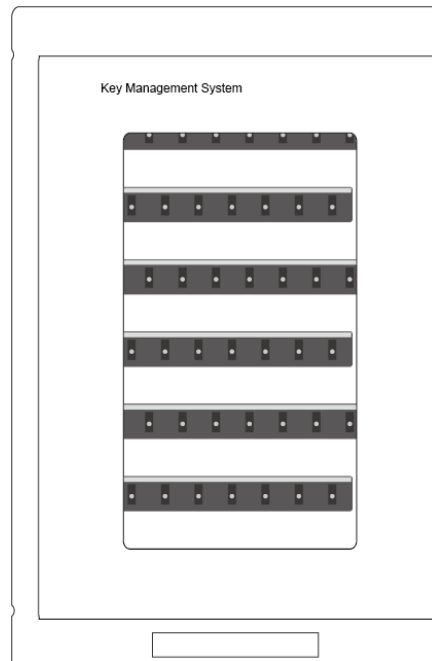

Step 2. Mark and drill 6 fixing holes and attach the wall bracket to the wall using the appropriate fixings.

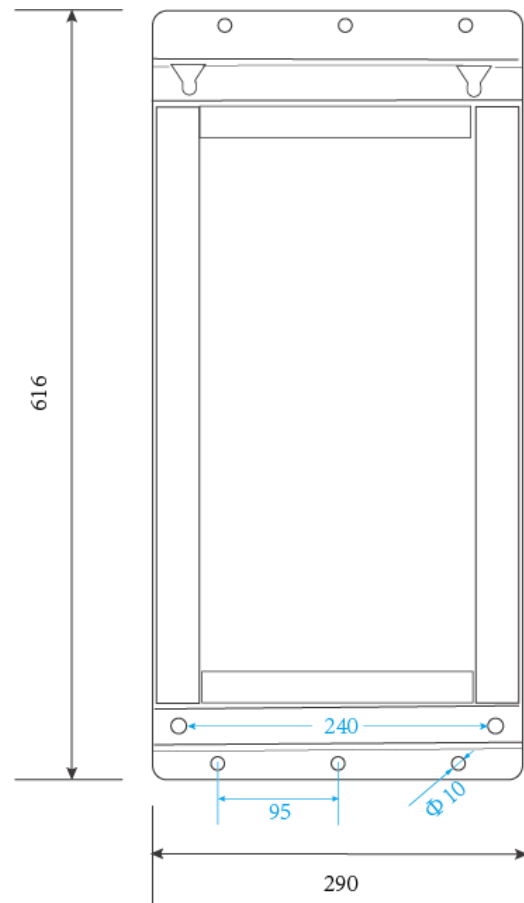

Step 3. Plug the power [and the ethernet] plugs.
Hang the key cabinet firmly on the bracket.

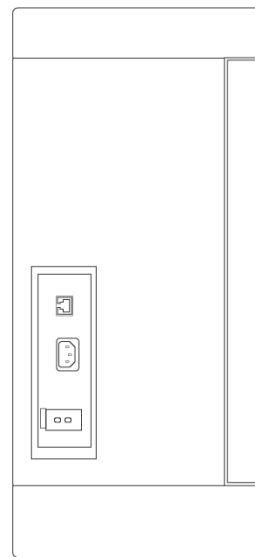

Step 4. Open the door, unscrew the two fixing screws, and then open the Key Panel using master keys.

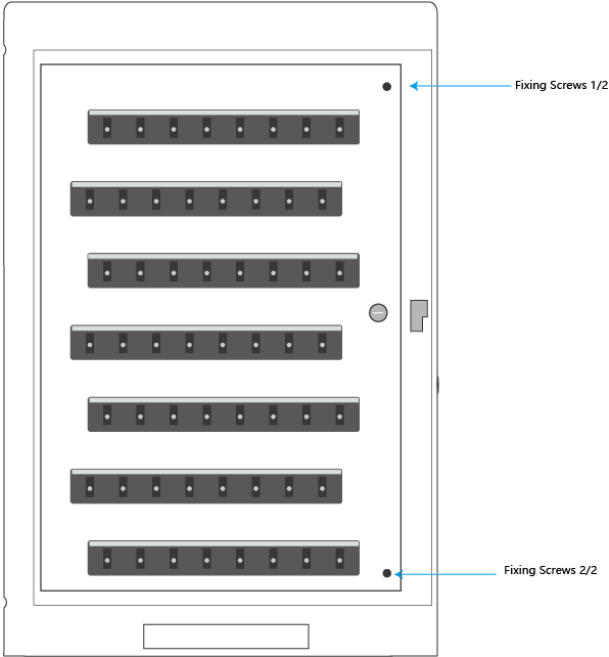

Step 5. Attach it to the bracket.

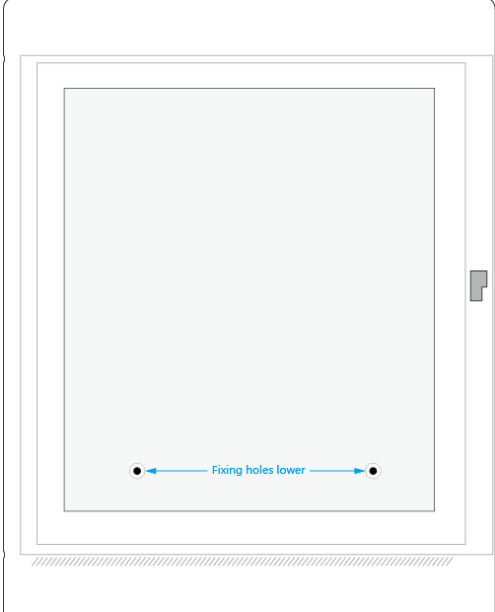

LANDWELL®

Beijing Landwell Electron Technology Co., Ltd

Floor 7, Eastern airport center, NO. 6 Tianxiang road, Beijing, China, 101316

vip@land-well.com

86-10-84717640